





Droguet-Caraco um 1760 Stadtmuseum Schärding

© www.marquise.de

nur zum privaten, nichtkommerziellen Gebrauch

-  Schnittlinie
-  Fischbeinstab
-  Stückelnaht / Ansatzlinie
-  verborgene Teile
-  Abnäher / Falte

 Raffung

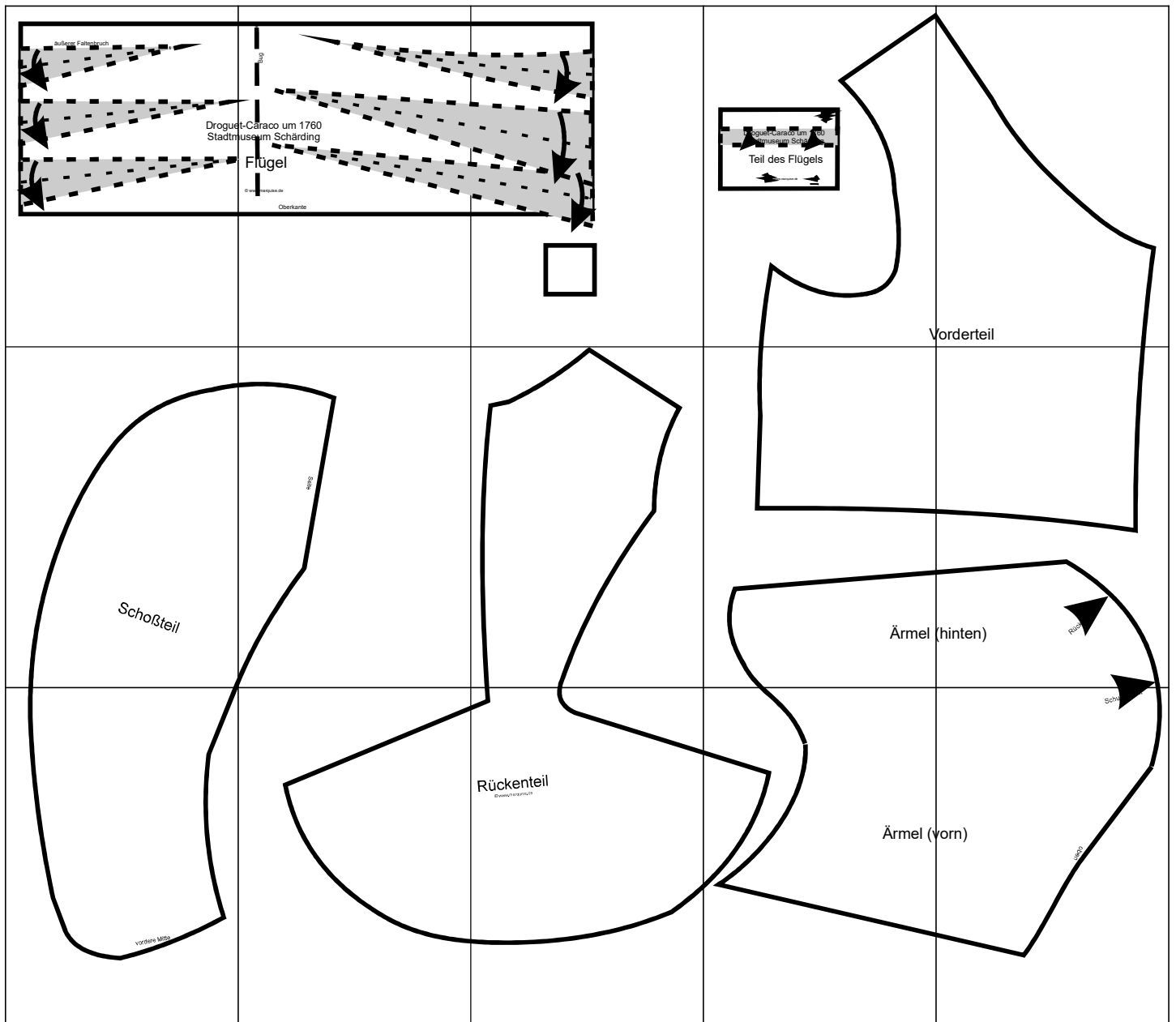

äußerer Faltenbruch

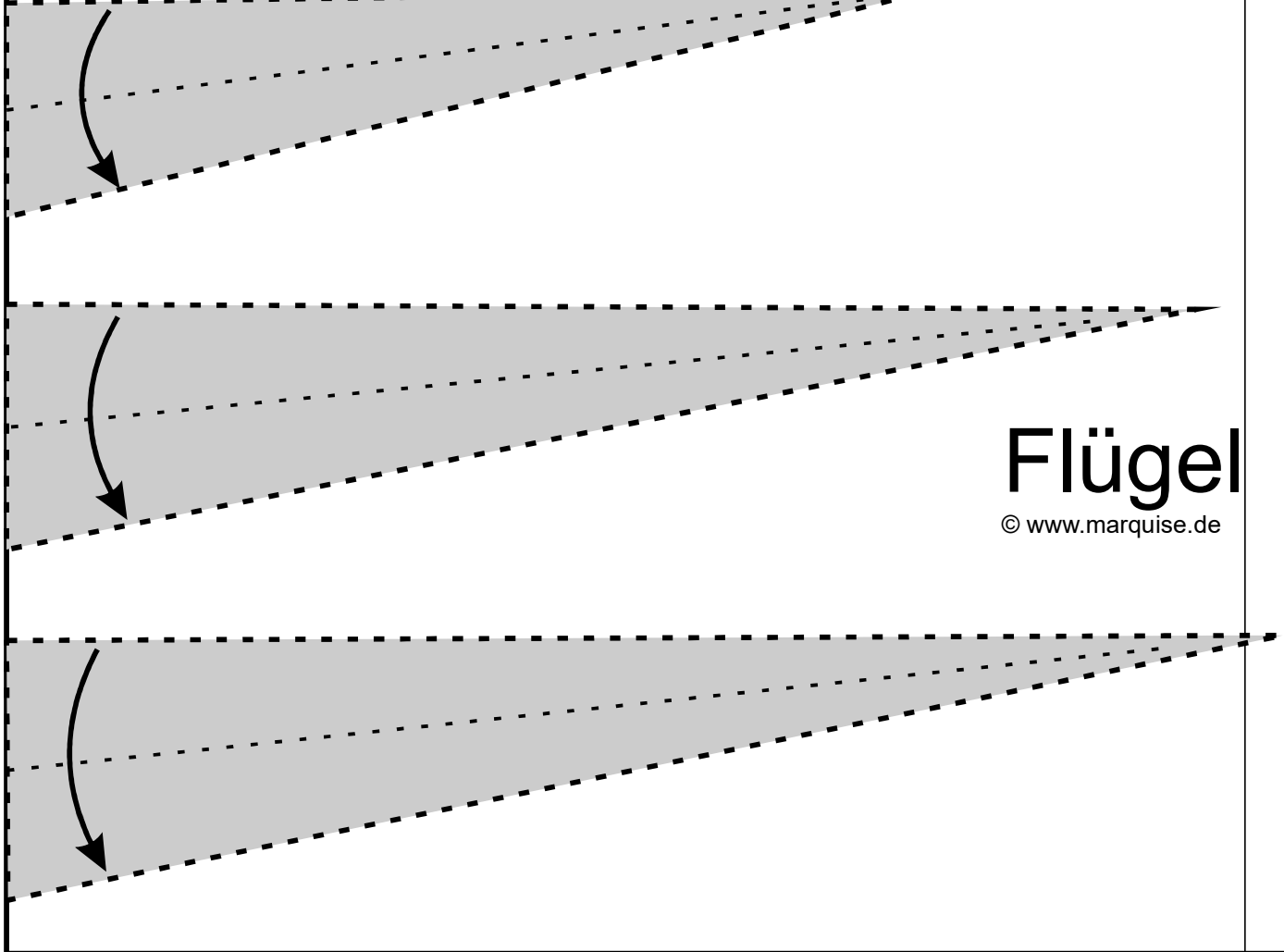

Flügel

© www.marquise.de

el
e.de

Bug

Oberkante

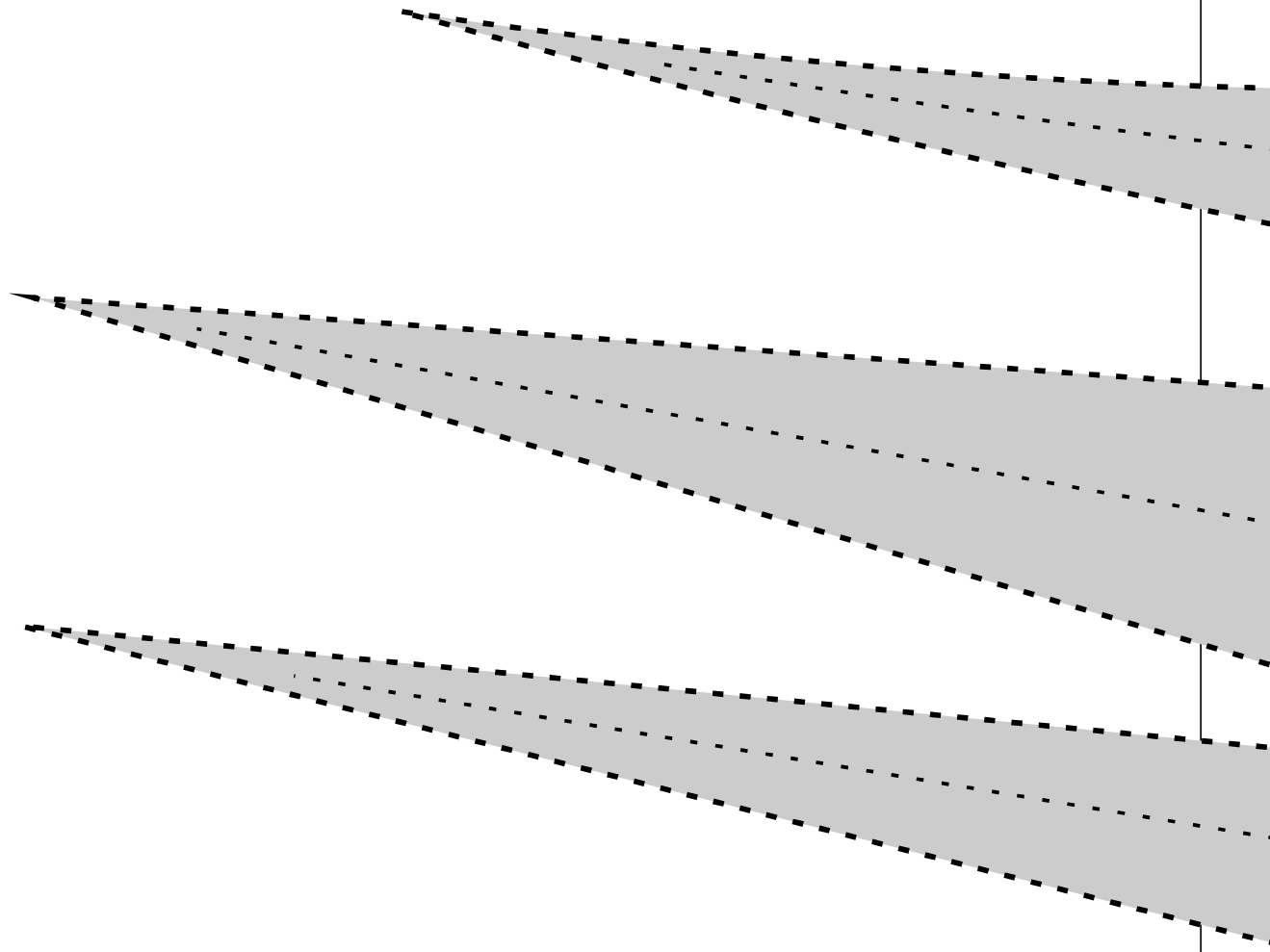

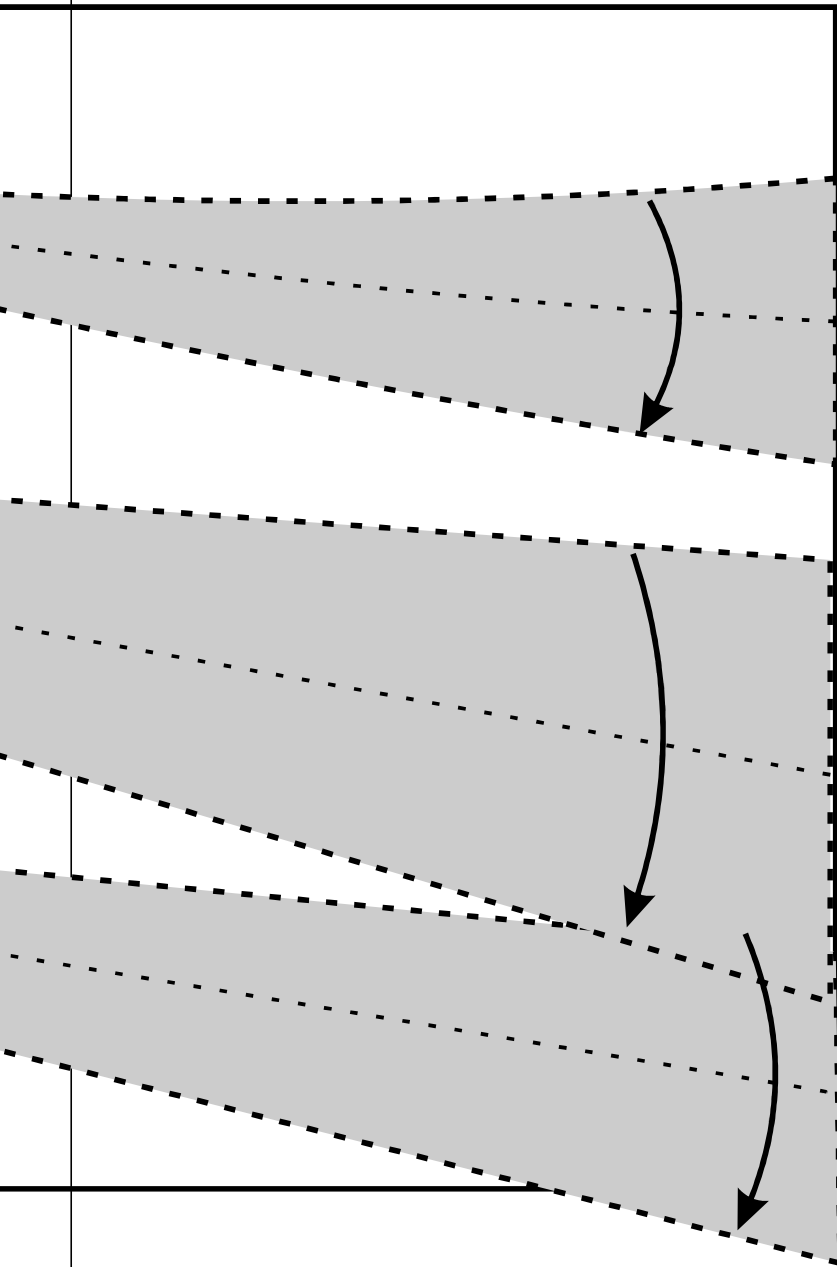

Dieses Quadrat muß
im Ausdruck
4 x 4 cm groß sein

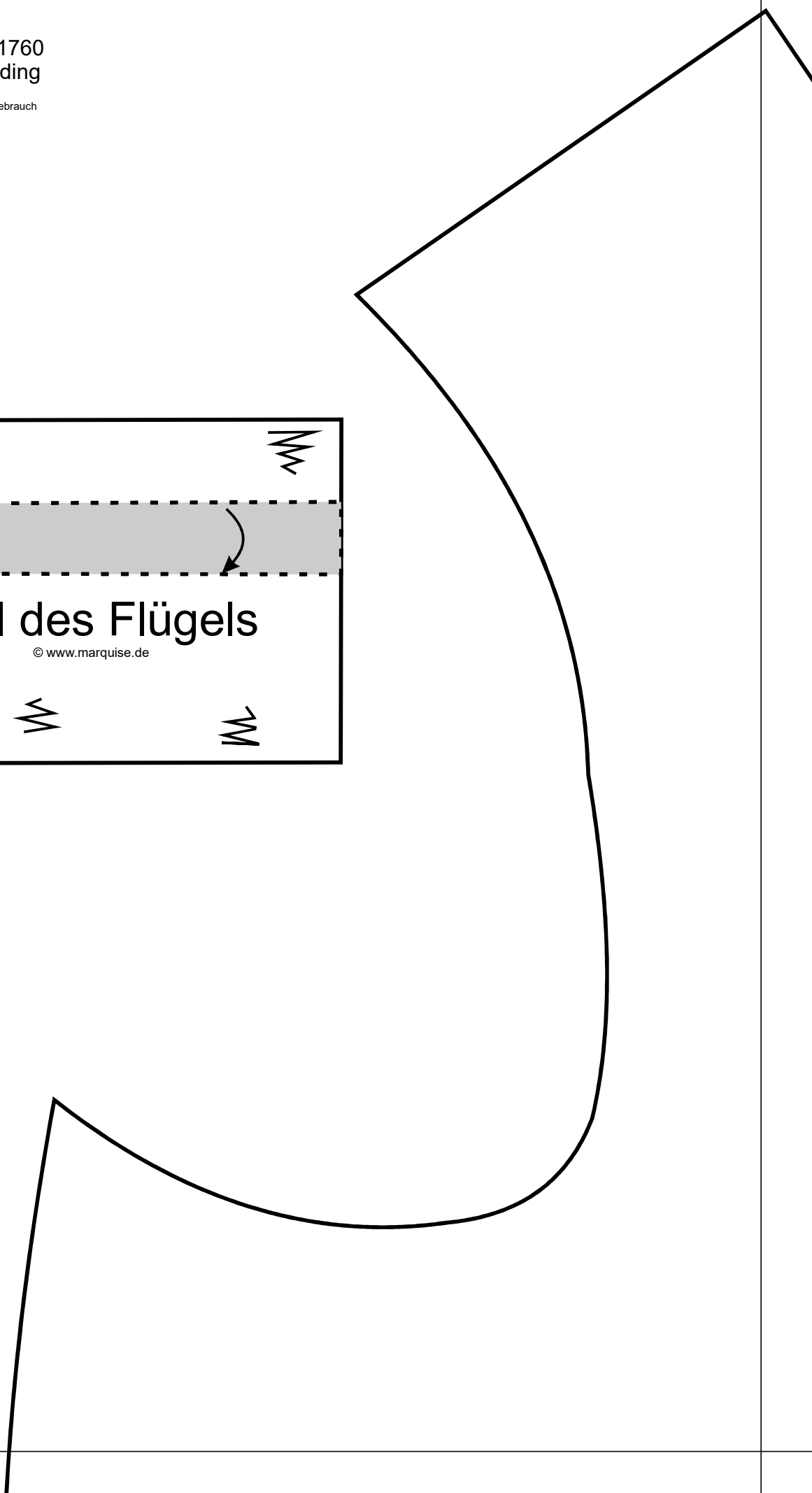
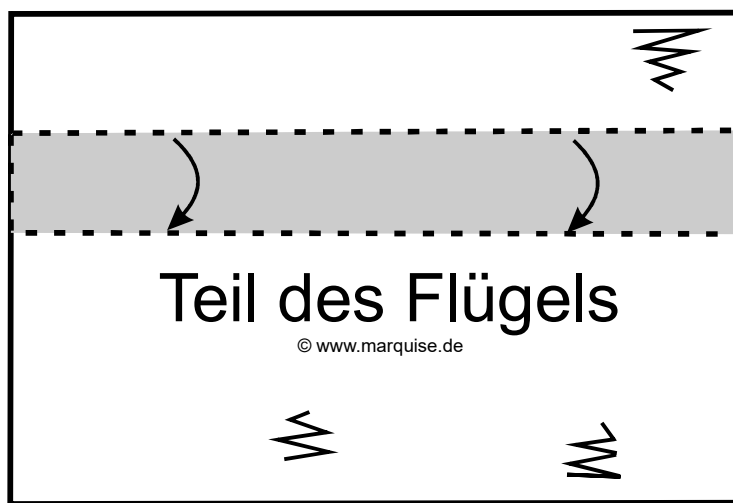

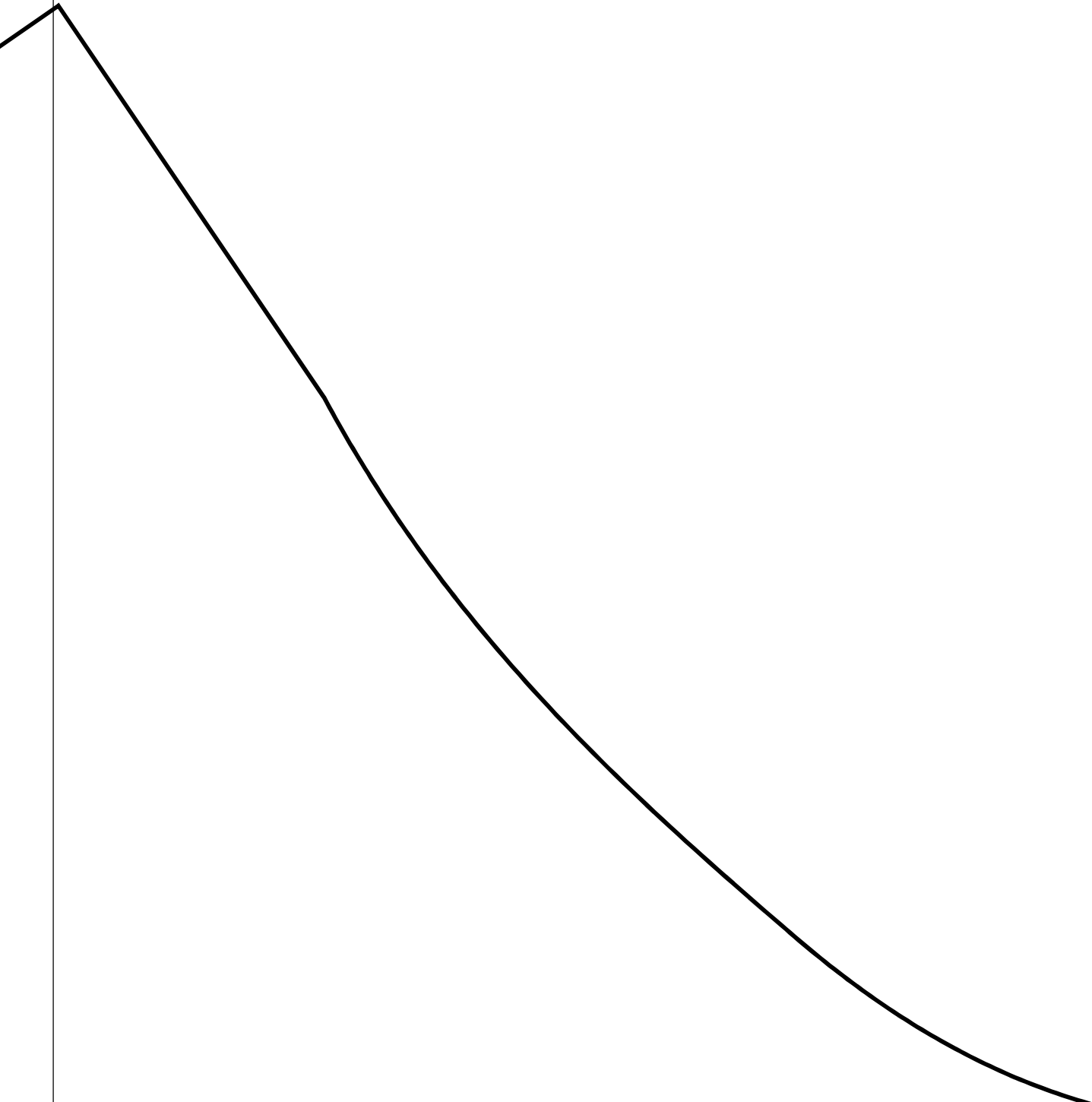

Vorderteil

Droguet-Caraco um 1760
Stadtmuseum Schärding

© www.marquise.de
nur zum privaten, nichtkommerziellen Gebrauch



Schoßteil



Seite

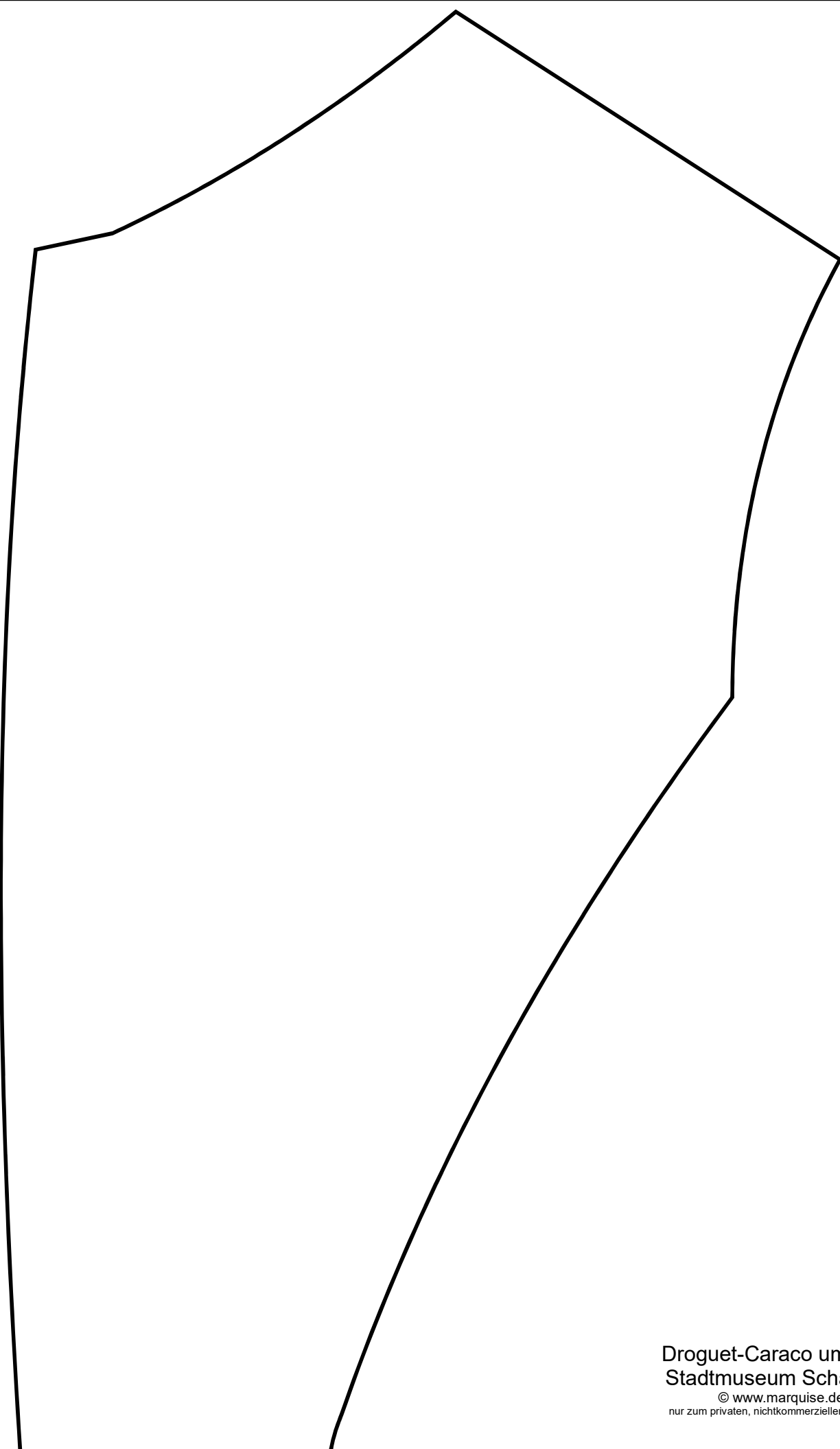

Droguet-Caraco um 1760
Stadtmuseum Schärding
© www.marquise.de
nur zum privaten, nichtkommerziellen Gebrauch

Droquet-Caraco um 1760
Stadtmuseum Schärding

© www.marquise.de
nur zum privaten, nichtkommerziellen Gebrauch

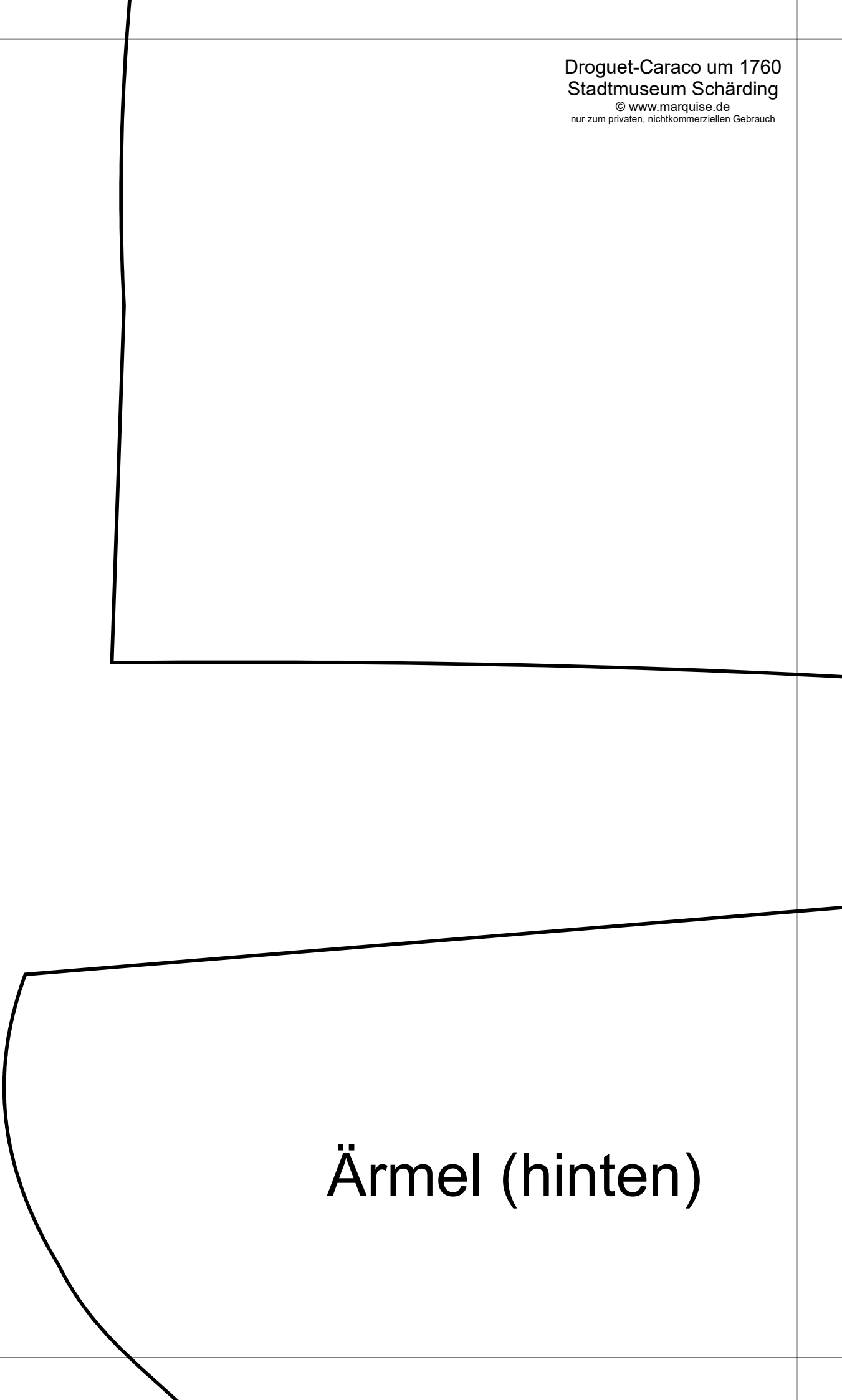

Ärmel (hinten)

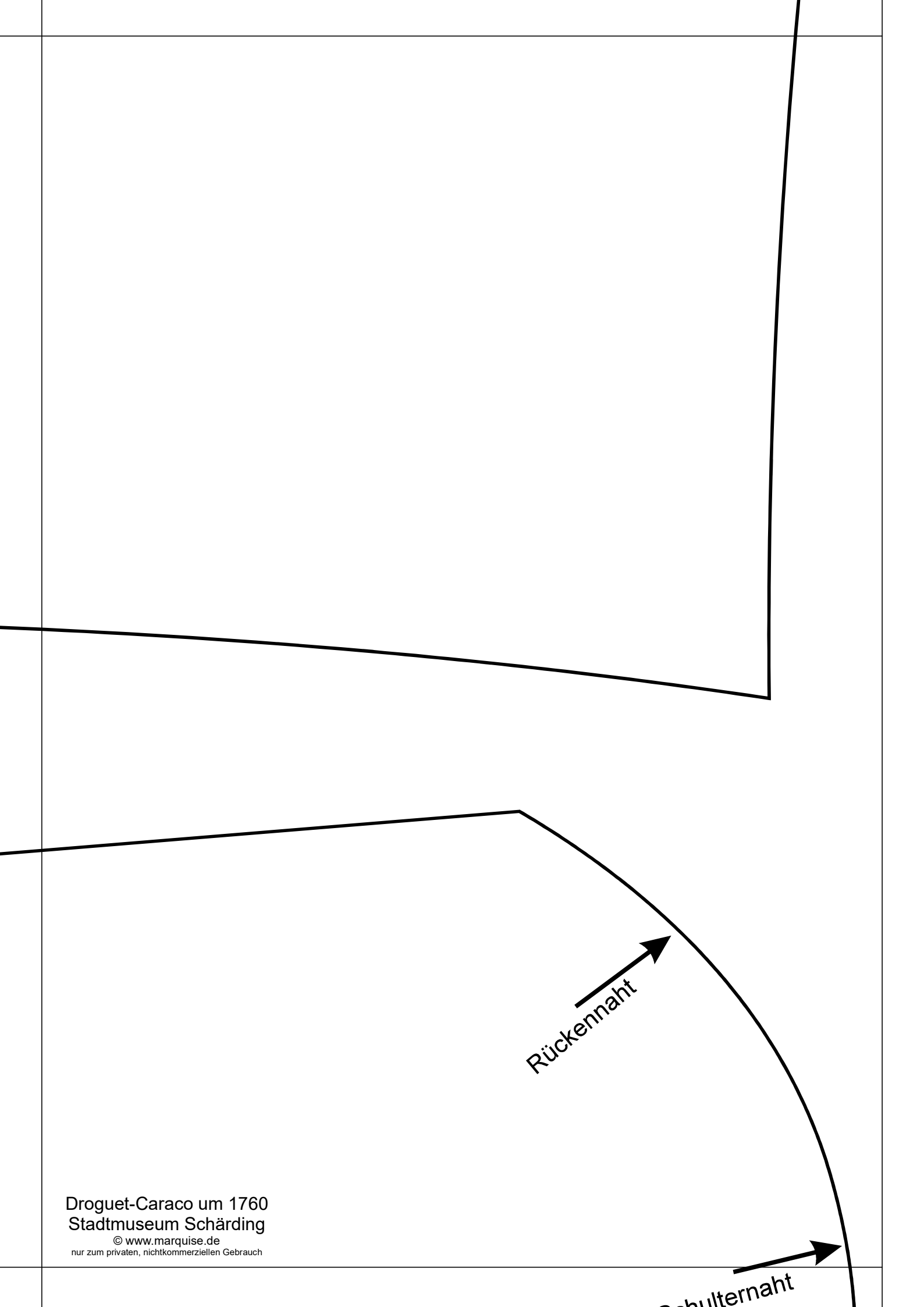

Rückennaht

Schulternaht

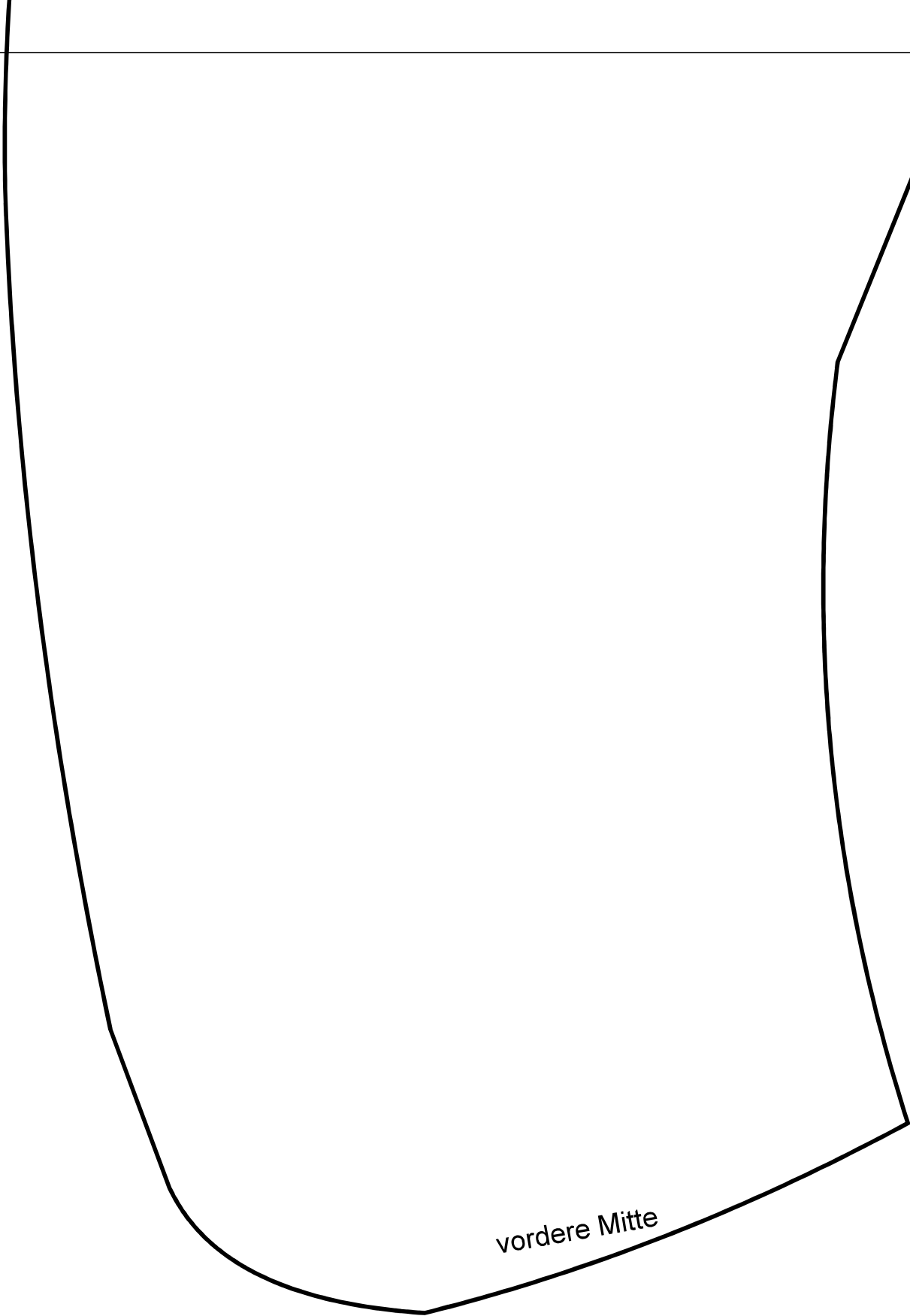

vordere Mitte

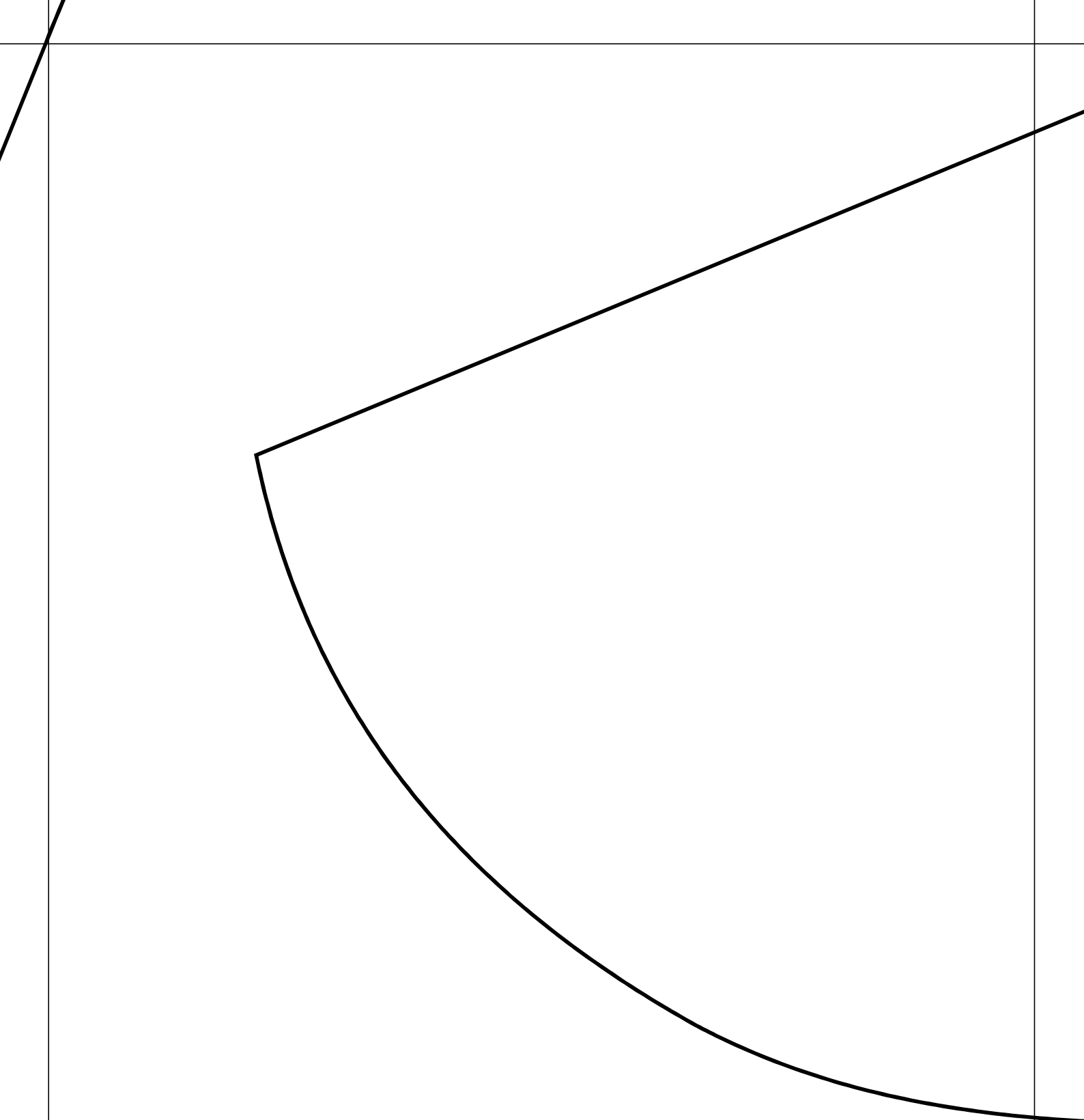

Droguet-Caraco um 1760
Stadtmuseum Schärding

© www.marquise.de
nur zum privaten, nichtkommerziellen Gebrauch

Rückenteil

© www.marquise.de

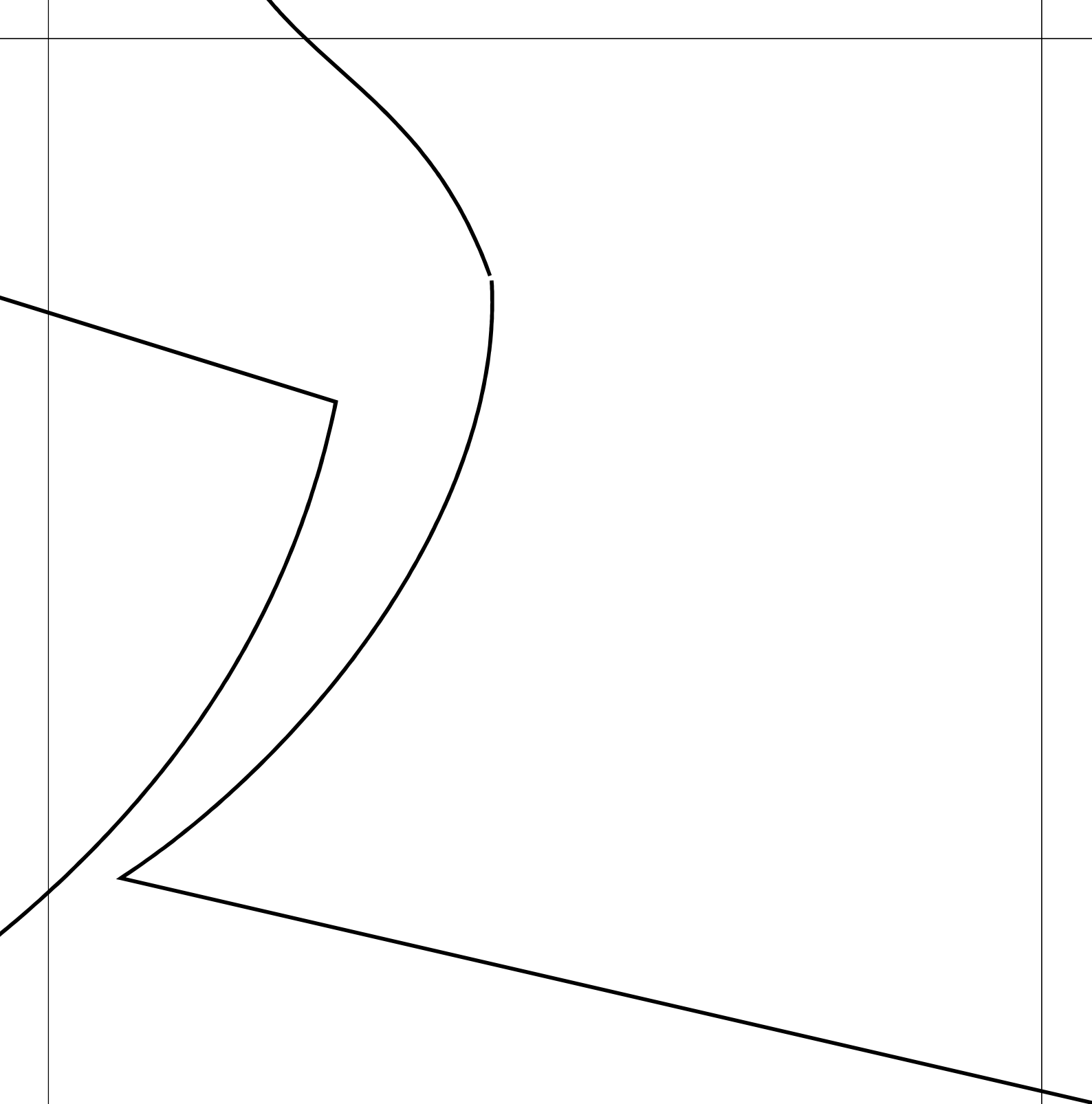

Droguet-Caraco um 1760
Stadtmuseum Schärding

© www.marquise.de
nur zum privaten, nichtkommerziellen Gebrauch

Schulternaht

Ärmel (vorn)

oben